

DPM 950

3½ Digit LCD Voltmeter

Very low current consumption results in a long battery life and makes the DPM 950 ideal for portable equipment. For low light viewing, a long life LED backlight is fitted. The meter is housed in a robust carrier which can be bolted in place or panel mounted using the bezel, window and clips provided.

- 🌀 19mm (0.75") Digit Height
- 🌀 IDC Interface
- 🌀 Auto-zero
- 🌀 Auto-polarity
- 🌀 200mV d.c. Full Scale Reading (F.S.R.)
- 🌀 LED Backlight
- 🌀 Single Rail Version
- 🌀 Alarm Annunciator



SCALING

Two resistors Ra and Rb may be fitted in order to alter the full scale reading (F.S.R.) of the meter - see table. The meter will need re-calibration.

Required F.S.R.		Ra	Rb
2V	Note	910k	100k
20V	Note	1M	10k
200V	Note	1M	1k
2kV	Note	1M	100R
200µA		LINK	1k
2mA		LINK	100R
20mA		LINK	10R
200mA		LINK	1R

NOTE
Ensure that Link 10 is open if fitting Ra.

Standard Meter		Stock Number		
Single Rail Version		DPM 950	DPM 950S	
Specification	Min.	Typ.	Max.	Unit
Accuracy (overall error) **		0.05	0.1	% (±1 count)
Linearity			±1	count
Sample rate		3		samples/sec
Operating temperature range	0		50	°C
Temperature stability		100		ppm/°C
Supply voltage (V+ to V-)	DPM 950	7.5	9	14
	DPM 950S	3.5	5	6.5
Supply current (not including backlight)	DPM 950	150		µA
	DPM 950S	500		
Backlight current *		50		mA
Input leakage current (Vin = 0V)		1	10	pA

* Supply voltage 5V nom.
** To ensure maximum accuracy, re-calibrate periodically.

CONNECTOR SOURCING GUIDE

METHOD	Cable Mounting IDC Supplied With Product
--------	--

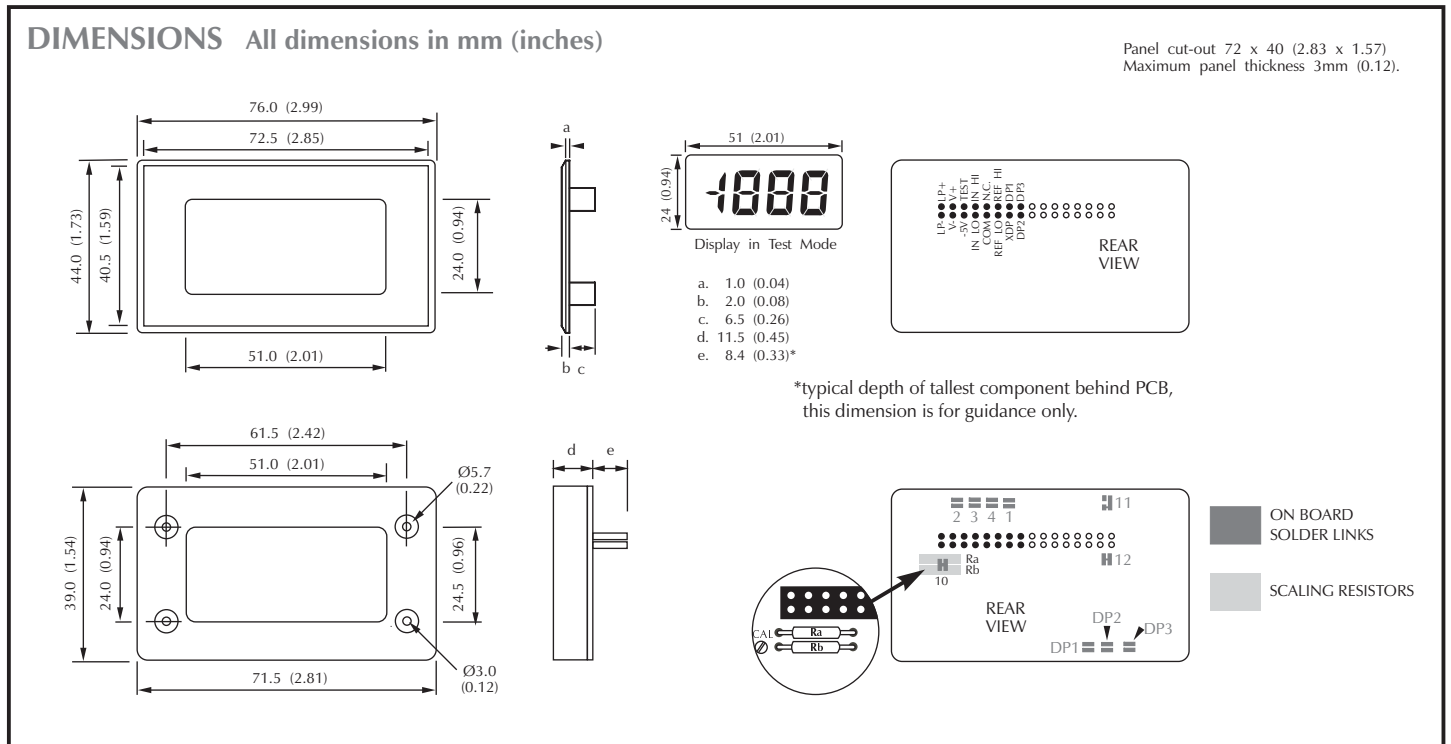

PIN FUNCTIONS

- | | | |
|-------------|---|---|
| 1. LP- | Negative power supply to LED backlighting. | |
| 2. LP+ | Positive power supply to LED backlighting. | |
| 3. V- | Negative power supply connection. | |
| 4. V+ | Positive power supply connection. | |
| 5. -5V | Output from negative rail generator circuit. This output is an inversion of V+ (DPM 950S only). | |
| 6. TEST | Connect to V+ to display all segments except DPs. It should not be operated for more than a few seconds as the D.C. voltage applied to the LCD may 'burn' the display. This pin is normally at 5V below V+ and is the ground for the digital section of the meter. It can be used to power external logic up to a maximum of 1mA. | |
| 7. IN LO | Negative measuring differential input. } Analogue inputs must be no closer than 1V to either positive or negative supply. The negative supply of the DPM 950S is generated internally and mirrors the positive supply voltage. | |
| 8. IN HI | | Positive measuring differential input. } |
| 9. COM | | Ground for the analogue section of the A/D converter, it is actively held at approximately 2.8V below V+ and must not be allowed to sink excessive current (>100µA) by, for instance, connecting to a higher voltage. |
| 11. REF LO | Negative input for reference voltage. Can be connected to COM via link 3. | |
| 12. REF HI | Positive input for reference voltage. Connected via link 1 to internal reference. | |
| 13. XDP | Annunciator Drive Waveform, this is an inversion of the backplane. | |
| 14. DP1 | 199.9 | |
| 15. DP2 | 19.99 | |
| 16. DP3 | 1.999 | |
| 18 & 32. BP | LCD backplane drive waveform. | |
| 23. REF- | Negative output from internal reference. | |
| 24. REF+ | Positive output from internal reference. | |
| 25. LO BAT | Used to control the low battery annunciator externally, cut link 12 and take to V+ to turn on annunciator. The annunciator turn on point can also be set by adjusting the BAT potentiometer (R10), in which case do not connect to this pin and leave link 12 intact. | |
| 26. REF BG | Output from internal bandgap reference. (Factory fitted option.) | |
| 27. | Alarm annunciator, cut link ALM and take to XDP to display. | |
| 28. : | Colon annunciator, cut link COL and take to XDP to display. | |
| 29. - | Polarity annunciator, connected via link 11 to polarity output of IC1. Cut link 11 and either take to XDP to display or make other side of link 11 to hold off. | |
| 30. POL | Polarity output of IC1. | |
| 31. CLK | May be used to override the internal oscillator and control the sample rate. Link 14 must then be made. | |

Only Pins 1-16 are fitted, these functions are available but a connector is not provided.

SAFETY

To comply with the Low Voltage Directive (LVD 93/68/EEC), input voltages to the module's pins must not exceed 60Vdc. If voltages to the measuring inputs do exceed 60Vdc, then fit scaling resistors externally to the module. The user must ensure that the incorporation of the DPM into the user's equipment conforms to the relevant sections of BS EN 61010 (Safety Requirements for Electrical Equipment for Measuring, Control and Laboratory Use).

VARIOUS OPERATING MODES

ON-BOARD LINKS: In order to quickly and easily change operating modes for different applications, the meter has several on-board links. They are designed to be easily opened (cut) or shorted (soldered). Do not connect more than one meter to the same power supply if the meters cannot use the same signal ground. Taking any input beyond the power supply rails will damage the meter.

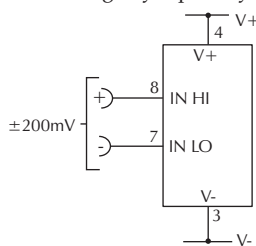

Check Links 2 & 3 are **SHORTED**.

Measuring a floating voltage source of 200mV full scale.

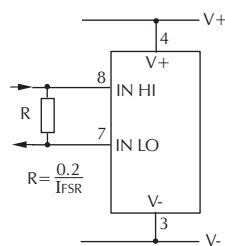

Check Links 2 & 3 are **SHORTED**.

Measuring current. Supply **MUST** be isolated.

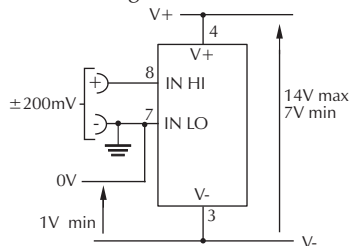

Check Link 3 is **SHORTED**.

Split rail supply (DPM 950)

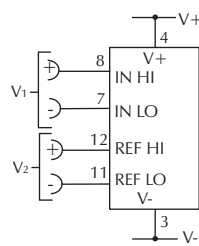

Check Links 1 & 4 are **OPEN**.

Measuring the ratio of two voltages.

Reading = $1000 V_1/V_2$
 $50mV < V_2 < 200mV$ $V_1 < 2V_2$

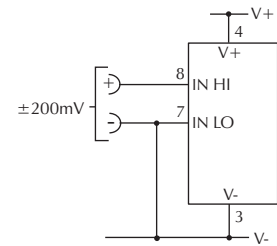

Check Link 3 is **SHORTED**.

Measuring a single ended input referenced to supply (DPM 950S).

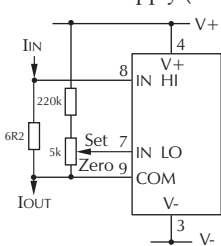

Check Link 3 is **SHORTED**.

Measuring 4-20mA to read 0-999 (supply **MUST** be isolated).